



Weatherstripping

Door Bottoms

Provides a seal against weather. For best results, use in conjunction with a threshold.

Fasteners: #6 x 5/8" Pan head sheet metal screws

- Notes:
- Lengths up to 48" are supplied 1/2" over their state size to allow for fitting
 - Lengths over 48" are supplied 1" over size
 - "Cut to exact length" may be specified
 - Constructed of strong extruded 6063-T5 aluminum

751S Finishes: MIL, DBA, GLD
 Inserts: V, N, S, W
 Category: J
 Certifications:

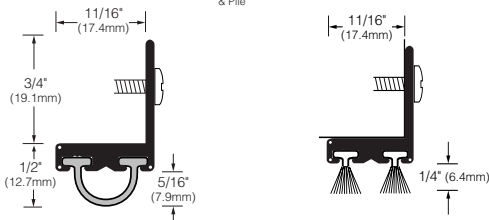

772S Finishes: MIL, DBA, GLD
 Inserts: V, N, S, W
 Category: J
 Certifications:

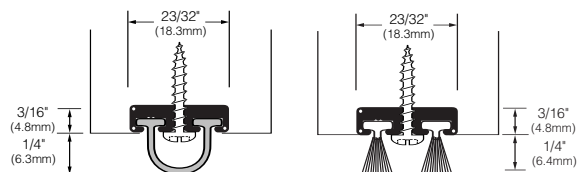

774S Finishes: MIL, DBA
 Inserts: V, N
 Category: J
 Certifications:

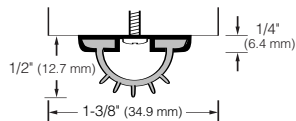

775S Finishes: MIL, DBA
 Inserts: V
 Category: J
 Certifications:

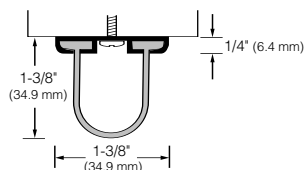

776S Finishes: CLR, DBA, GLD
 Inserts: N
 Category: J
 Certifications:

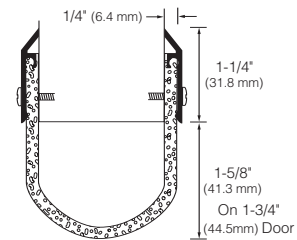

777S Finishes: MIL, DBA, GLD
 Inserts: V, N
 Category: J
 Certifications:

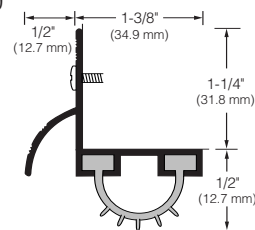

778S Finishes: MIL, DBA, GLD
 Inserts: V, N
 Category: J
 Certifications:

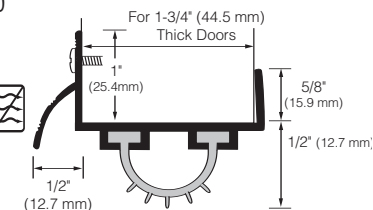

779S Finishes: MIL, DBA, GLD
 Inserts: V, N
 Category: J
 Certifications:

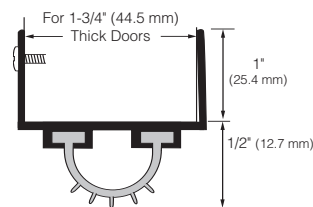

780S Finishes: MIL, DBA, GLD
 Inserts: V, N
 Category: J
 Certifications:

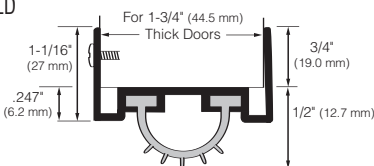

Finish Codes • MIL - mill finish aluminum • DBA - dark bronze anodized • GLD - gold anodized
CLR - clear anodized



Insert Codes • V - Vinyl • N - Neoprene, EDPM, or TPE • S - Silicone • W - Pile



Door Bottoms

Automatic Door Bottoms

781S

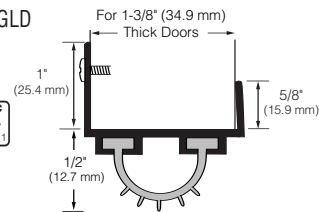

Finishes: MIL, DBA, GLD
 Inserts: V, N
 Category: J
 Certifications:  



Provides an outstanding seal against drafts, light, smoke and sound. For best results, use in conjunction with a threshold. When door fully closes, the gasket extends downward to provide a seal. Gasket retracts when door is opened.



- Fasteners:
- #8 x 1/4" Pan head sheet metal screws furnished with surface mount types
 - #6 x 5/8" Pan head sheet metal screws furnished with mortise types
- Notes:
- Furnished exact length as stated. May be trimmed for fitting (2" maximum).
 - Furnished with end cover and strike plates

782S

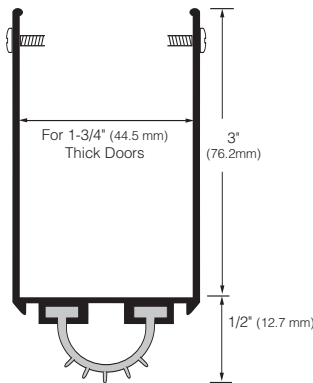
Finishes: MIL, DBA, GLD
 Inserts: V, N
 Category: J
 Certifications:  



730S

Finishes: MIL
 Inserts: N, S
 Category: J
 Certifications:  

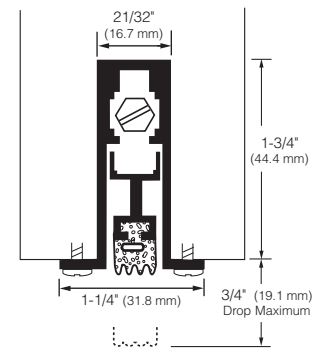

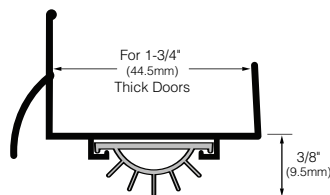

783S

Finishes: MIL, DBA, GLD
 Inserts: V



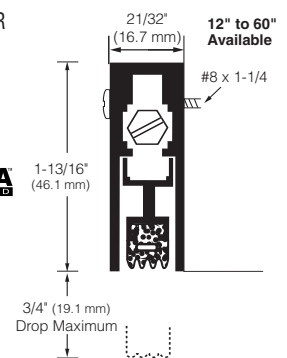

740S

Finishes: DBA, GLD, CLR
 Inserts: N, S
 Category: J
 Certifications:   



787S

Finishes: MIL
 Inserts: N
 Category: J
 Certifications:  

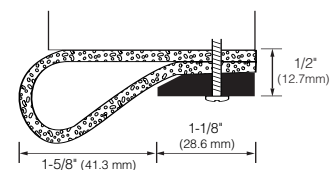

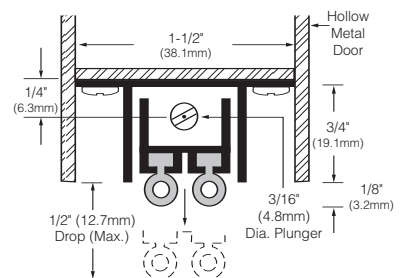

742S

Finishes: MIL
 Inserts: V
 Certifications: 



789S

Finishes: MIL, DBA, GLD
 Inserts: W
 Category: J
 Certifications:  

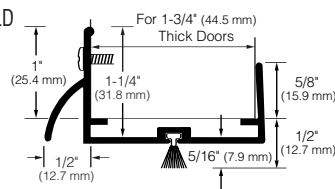

Finish Codes • MIL - mill finish aluminum • DBA - dark bronze anodized • GLD - gold anodized
 CLR - clear anodized

Insert Codes • V - Vinyl • N - Neoprene, EPDM, or TPE • S - Silicone • W - Pile



Weatherstripping

Automatic Door Bottoms

Door Bottom Sweeps

743S

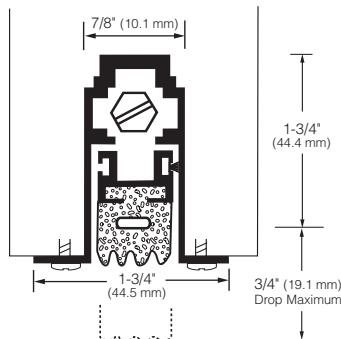

Finishes: MIL
 Inserts: N
 Category: J
 Certifications:  



Typically door bottom sweeps are used on the exterior of an outswing door

- Fasteners: #6 x 5/8" Pan head sheet metal screws furnished with mortise types
- Notes:
- MIL finish weatherstripping is supplied with zinc plated screws
 - Brass weatherstripping is supplied with brass screws
 - Color anodized weatherstripping is supplied with screws plated to match
 - Stainless steel weatherstripping is supplied with stainless steel screws

747S

Finishes: MIL, DBA, CLR
 Inserts: N
 Category: J
 Certifications:   

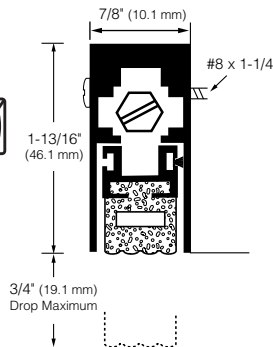

750S

Finishes: DBA, GLD, MIB, CLR, 32D
 Inserts: N, S
 Category: J
 Certifications:   

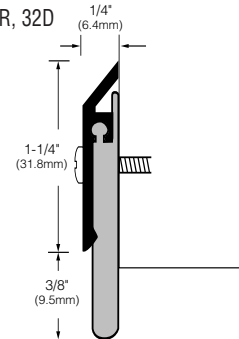

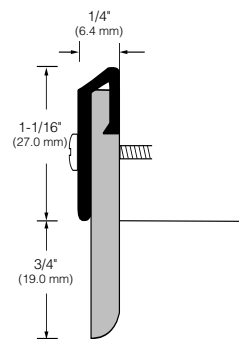

752S

Finishes: MIL, DBA, GLD
 Inserts: V
 Category: J
 Certifications:  



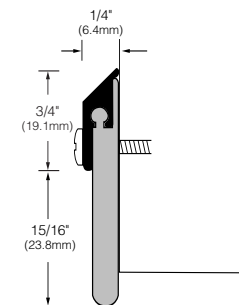

753S

Finishes: MIL, DBA, GLD
 Inserts: N
 Category: J
 Certifications:  



754S

Finishes: DBA, GLD, CLR
 Inserts: N
 Category: J
 Certifications:   

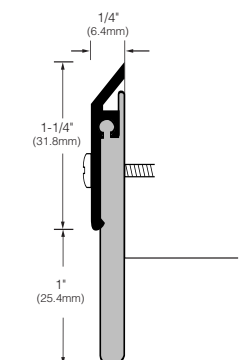

Finish Codes • MIL - mill finish aluminum • DBA - dark bronze anodized • GLD - gold anodized
 • MIB - mill finish bronze • CLR - clear anodized • 32D - Stainless Steel

Insert Codes • V - Vinyl • N - Neoprene, EDPM, or TPE • S - Silicone