



# Weatherstripping





## Door Bottom Sweeps

**756S**

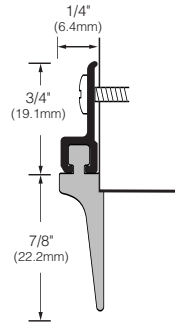
Finishes: MIL, DBA, GLD  
 Inserts: V  
 Category: H, J  
 Certifications:  



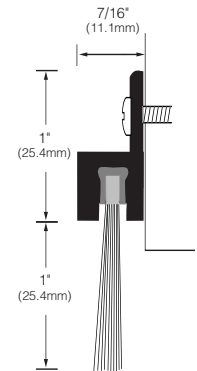

**801S**

Finishes: MIL, DBA, GLD  
 Inserts: B  
 Category: J  
 Certifications:  



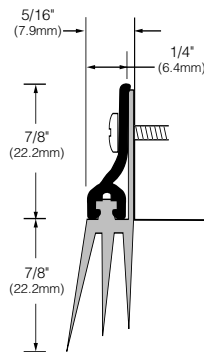

**759S**

Finishes: MIL, DBA, GLD  
 Inserts: V  
 Category: J  
 Certifications:  



**802S**

Finishes: MIL, DBA, GLD  
 Inserts: B  
 Category: H, J  
 Certifications:  

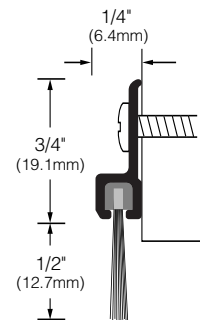

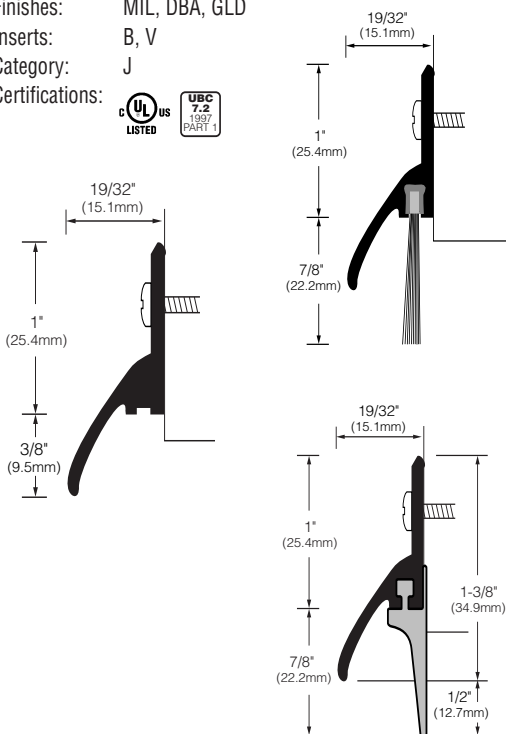

**770S**

Finishes: MIL, DBA, GLD  
 Inserts: B, V  
 Category: J  
 Certifications:  



**806S**

Finishes: MIL, DBA, GLD  
 Inserts: B  
 Category: J  
 Certifications:  

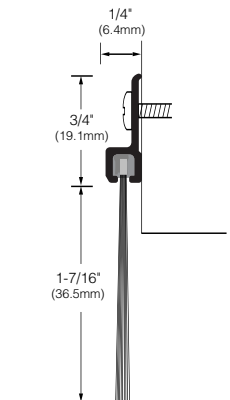

**872S**

Finishes: DBA, GLD, MIB, CLR, 32D  
 Inserts: N  
 Category: H, J  
 Certifications:  

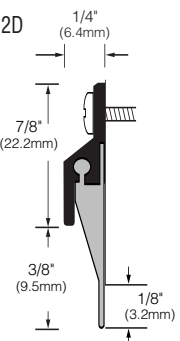

Finish Codes • MIL - mill finish aluminum • DBA - dark bronze anodized • GLD - gold anodized  
 MIB - mill finish bronze • CLR - clear anodized • 32D - Stainless Steel

Insert Codes • V - Vinyl • N - Neoprene, EDPM, or TPE • B - Nylon Brush

800-325-9995  
 www.hagerco.com